

H4 SERIES

HMK 390 LC HD



HIDROMEK





New H4 Series

Innovation coming from experience

Being produced with developed hydraulic system design, HIDROMEK's new H4 Series excavators offer an outstanding performance by working faster, more productively and more efficiently. H4 Series excavators produce more work with less fuel; hence, they are more profitable for their users than ever.

H4
SERIES

Performance.....	6-7
Durability.....	8-11
Safety.....	12-13
Technology.....	14-15
Comfort.....	16-17
HIDROMEK Smartlink - Ease of Service.....	18-19
Technical Features	20-25

The information and images, and equipment presented in this brochure are either standard or optional depending on the configuration. HIDROMEK has the right to modify the specifications and the designs of the model indicated in this brochure without prior notice.









More work within less time

17 % More productive*

Shortening the work cycle time with bigger bucket capacity and speed, H4 Series carry the productivity to the top level with their new technology.

14 % More efficient*

With improvements to the attachment and hydraulic group, H4 Series excavators ensure more work within less time.

6 % Faster*

With faster hydraulic movements due to developed hydraulic system design, H4 Series excavators ensure more work within less time.



For product video

* The data are prepared in comparison with the previous serie in HP mode.



More durable

Produced to have reinforced heavy duty construction considering maximum performance, long life and smooth operation in severe field conditions, HİDROMEK excavators ensure more durability with the improvements made in the new H4 Series.





① More durable anti-wearing plates (Hardox 450 HB)



② Optimized bucket form



③ Reinforced arm supporting parts



④ Reinforced casting tip



⑤ Heavy duty arm



⑥ Reinforced boom structure

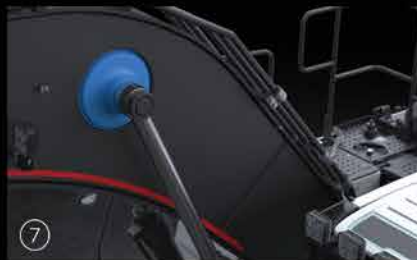

⑦ Reinforced boom cylinder cast bearing



⑧ Reinforced lowerframe and undercarriage components

Reinforced heavy duty construction

With their reinforced heavy duty construction produced at HÍDROMEK's modern production facilities and going through sensitive quality-control processes, H4 Series excavators have excellent durability.

Bronze-Graphite Bushings



Bronze-graphite bushings used in boom-arm and boom-frame connection points increase the lubrication period, and greatly prevent the wear of the pins because of graphite, having a very high grease absorption and retention capability, embedded in the inner structure of the bushings.



Safeworkingenvironment

ROPS&FOPS cabin

Having the standards of ROPS (Roll Over Protective Structure) & FOPS (Falling Object Protective Structure), H4 Series excavators provide maximum safety and durability.

Wide vision capacity

Designed with giving special importance to occupational safety, H4 Series ensure excellent vision by minimizing the blind spot on the side and rear cameras. Along with the increase in the number of led headlights, the night vision is significantly improved on H4 Series excavators; in addition, there are also red handles and warning labels providing maximum safety for the operator.

Audio warning systems

H4 Series excavators enable safer working environment with their automatic starting horn, swing warning system and travel warning system.

Flame holder system

Where sparks are dangerous, regeneration inhibit feature is activated from the cabin, so flame from the exhaust is prevented temporarily.



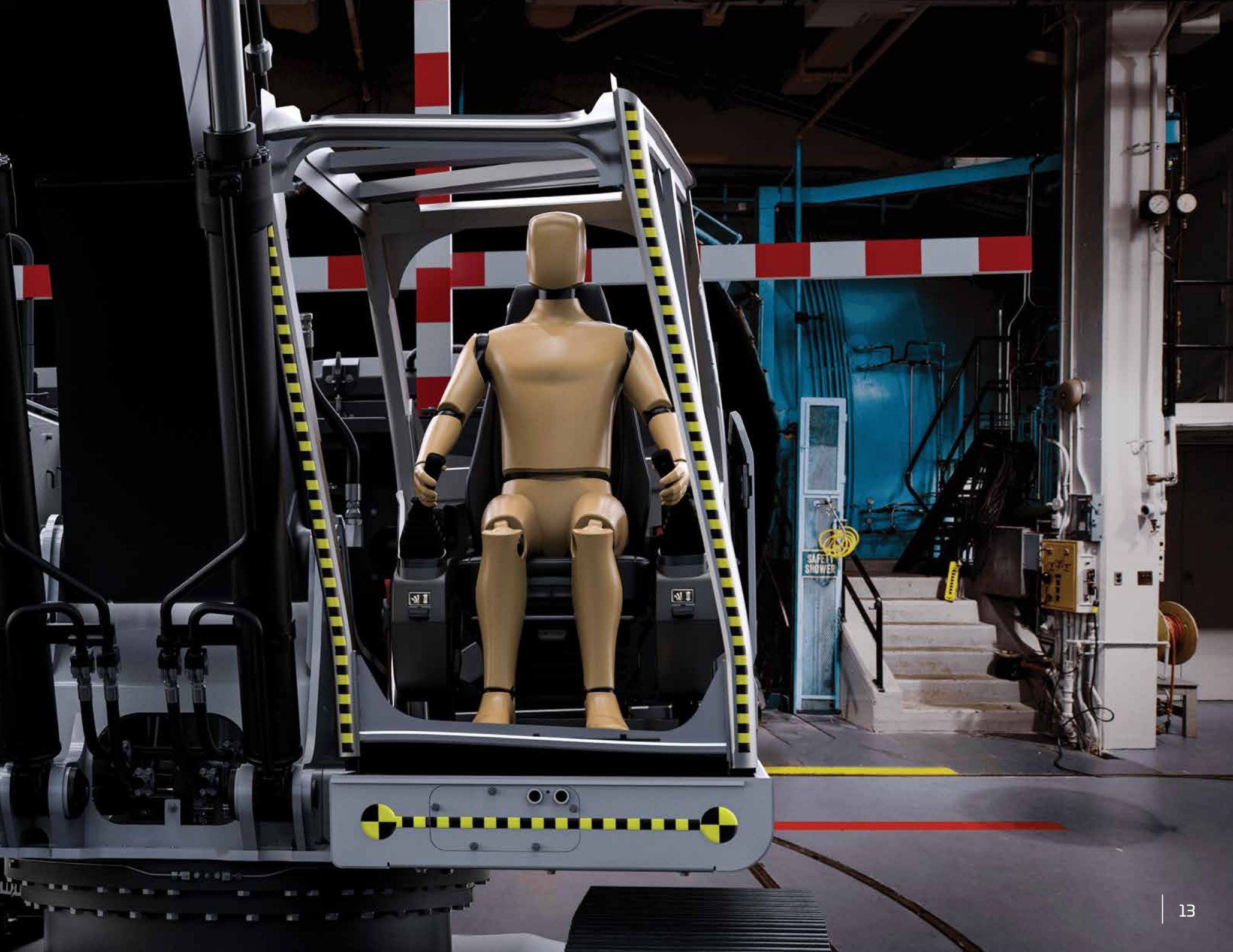

Shaped with technology

Electronic system of H4 Series excavators designed to protect the engine and hydraulic components to provide fuel saving and superior performance.

Automatic stop system

In the new series, automatic stop system through configurable idling and stopping times provides fuel saving by stopping the engine after the machine is on idle. Automatic stop system in H4 Series helps to decrease the operational costs to minimum, and contributes to saving the environment.

Safe fuel transfer pump

“Safe fuel transfer pump” added to H4 Series stops the pump automatically when the tank is full and this feature gets activated also when the pump does not transfer fuel for 30 seconds, and ensures that the pump stops automatically.

Power boost technology

In H4 Series, power boost technology gets activated automatically in the conditions when the machine needs extra power, and ensures that the machine has the proper performance for the work.

8” Touch control panel

8 inch touch control panel is positioned ergonomically at a point that the operator can easily reach it. Touch control panel having high quality hardware and a large screen easily enables to control the machine features and access to machine information.

The features of touch control panel:

- It offers multi-language option
- Music system is integrated into 8” touch control panel.
- It allows the operator to adjust the flow required for the attachment without leaving the cab and save this information for 20 different attachments.
- During travel, rear and side view cameras with improved image quality and activated automatically can be controlled.
- Information on the average and instant fuel consumption can be obtained.
- Information on status such as atmospheric pressure, turbo boost pressure, fuel pressure and hydraulic pump pressure can be obtained.
- User can acquire working hour information such as work, attachment and travel.
- Maintenance registries can be obtained, and the user is warned when the maintenance time approaches.
- Failure codes and registries can be obtained.
- Audio warning systems can be controlled.





OPERA, the guide of the field

H4 Series excavators are equipped with Opera (HIDROMEK Operator Interface) for the operator to use the machine easily, and feel comfortable and relaxed as he is in an office environment.

Functions to be controlled by means of Opera

- Engine RPM control
- Access to control panel menu
- Functions of lights, windshield wipers and rear view camera
- Music system control
- Auto stop control of the engine to ensure maximum fuel economy during low idle
- On H4 Series machines, the preheating system available to protect the engine and hydraulic systems can be controlled via Opera.

The aesthetic design of power

The seat ergonomic, heated, air suspended and having 35 degrees adjustable backrest angle is provided in H4 Series, and it enables the operator to work comfortably and without getting tired for long working hours.

H4 Series which has many features* such as proportional control pedals and joysticks, throttle control dial, operator touch screen, interior light, cup holder and heating-cooling box give more importance to user comfort.

HIDROMEK

* Other features for user comfort on H4 Series machines can be found on page 21.

Office comfort in construction equipment

Automatic air conditioning system

Air vents and air conditioning system which can automatically adjust itself according to the ambient heat located in the redesigned cabin provide the best cooling performance in its class by 30%.

Wide angle view

On the new series machines, the new two-piece windshield wiper system designed for creating more comfortable work environment provides a wide angle view which increases the work efficiency of the user.

Led headlights for night vision

Led headlights on new H4 Series machines improve the night vision, and enable the operator to work more safely and comfortably.

Dampers

By using 6 silicone dampers on H4 Series excavators, noise, shock and vibration are absorbed and prevented from being transmitted to the cabin under any working condition.



You have the control with HÍDROMEK **SmartLink**

Telematic system HÍDROMEK Smartlink allows the user to easily access to machine location and technical information via computer and mobile phone.

Follow the work time and location of your machine through HÍDROMEK Smartlink!

Through GPS tracking system, it is possible to track the location and the work time intervals of the machine.

Analyze your fuel consumption through HÍDROMEK Smartlink!

It is possible to analyze fuel consumption according to the working conditions of the machine and daily fuel parameters.

Check the works for which your machine has been used through HÍDROMEK Smartlink!

Through working mode information, it is possible to see the daily and total working hours of the machine for excavation and leveling and with crusher or with other optional attachments besides the power mode information and the speed ranges.

Follow your machine's maintenance through HÍDROMEK Smartlink!

Under the Alerts list, the machine's upcoming maintenance can be checked while the information of the nearest authorized service can be obtained, and it can be contacted.

Contact the nearest authorized service or regional service through HÍDROMEK Smartlink!

With the application, it is possible to obtain the information on Regional and Authorized Services of HÍDROMEK After Sales Services as well as the directions to them.

Have performance reports for the selected periods of time for your machines through HÍDROMEK Smartlink!

For any selected periods of time, it is possible to have a report on daily fuel consumption, average fuel consumption, power and working modes, daily work time intervals and locations.



To download Smartlink application





Easy maintenance and fast service for H4 Series through safe and easy access

H4 Series excavators, designed considering fast access to hydraulic and engine equipment, provide easy maintenance and service. Most of the maintenance can be easily carried out without getting on the machine, which shortens the service time and increases machine work time.

Automatic greasing system ensures that all parts of the machine can be lubricated from one single center.



ENGINE

Brand & Model	ISUZU-6HK1X
Type	Water cooled, 4 cycles, 6 cylinders, inline, diesel engine with direct injection, turbocharger and intercooler
Power Gross	281 HP (210 kW) @1900 rpm / SAE J1995
Maximum Gross Torque	1080 Nm @1500 rpm
Displacement	7790 cc
Bore x Stroke	115 mm x 125 mm
Emission Class	EU: Stage V

HYDRAULIC SYSTEM

MAIN PUMP

Type	2 axial piston pumps with variable displacement and swashplate
Max. Flow Rate	2 x 300 L/min
Pilot Pump	Gear type, 28,5 L/min

WORKING PRESSURE

Attachment	350 kgf/cm ²
Power Boost	380 kgf/cm ²
Travel	350 kgf/cm ²
Swing	285 kgf/cm ²
Pilot	40 kgf/cm ²

HYDRAULIC CYLINDERS

Boom	2 x ø 145 x ø 100 x 1.510 mm
Arm	1 x ø 170 x ø 120 x 1.735 mm
Bucket	1 x ø 145 x ø 105 x 1.280 mm

SWING SYSTEM

Swing motor	Fixed swashplate piston motor integrated with super shock absorber valve
Reduction	2 stage, planetary gear type
Swing Brake	Hydraulic disc type, pilot operated and automatically released
Swing Speed	9,4 rpm

LOWER FRAME

Construction	"X" type lower frame with pentagon shaped box type side frames
Shoe	Triple grouser
No. of Shoes	2 x 50 pieces
No. of Lower Rollers	2 x 9 pieces
No. of Upper Rollers	2 x 2 pieces
Full Trackguard	Complete
Track Tensioner	Hydraulic type with spring cushioning

ELECTRICAL SYSTEM

Voltage	24 V
Battery	2 x 12 V / 150 Ah
Alternator	24 V / 50 A
Starter Motor	24 V / 5 kW

TRAVEL AND BRAKES

Travel	Fully hydrostatic
Travel Motor	Axial piston motor with 2 speed stages and swashplate
Reduction	2 stage, planetary gear type
Travel Speed	High Speed 5,0 km/h Low Speed 2,9 km/h
Max. Traction	30.470 kgf
Gradeability	35° (%70)
Parking Brake	Hydraulic disc type, pilot operated and automatically released
Ground Pressure	0,72 kgf/cm ²

FILLING CAPACITIES

Fuel Tank	565 L	Engine Cooling System	55 L
Hydraulic Tank	265 L	Engine Oil	44 L
Hydraulic System	470 L	Urea	70 L

OPERATING WEIGHT (kg)

	Mono Boom	LR
HMK 390 LC HD	40.300	42.400
HMK 390 NLC	40.100	-

EQUIPMENT

HMK 390 LC HD

Engine	Standard	Optional
Water cooled diesel engine with turbocharger and intercooler	●	
Engine pre-heat function	●	
Automatic idling	●	
One touch auto-idle system	●	
Automatic stop function	●	
Two-stage air filter	●	
Air filter clogged indicator	●	
Low engine pressure warning system	●	
Overheat warning system	●	
Adjustable power modes	●	
High altitude working function	●	
Electronical engine control	●	
Hydraulic System		
Boom and arm regeneration valve	●	
Automatic power boost	●	
Smooth boom feature		0
Main hydraulic filter	●	
Backup ports (valve)	●	
Cylinder cushioning and contamination seals	●	
Single-acting hydraulic line, breaker		0
Double- acting hydraulic line, crusher		0
Additional line		0
Quick coupling line		0
Attachment settings through instrument panel		0
OPERATOR'S CAB		
Pressurized and sound isolated cabin	●	
Air-conditioning	●	
Air-suspension seat	●	
Heated seat		0
Operator touch screen	●	
Opera control system	●	
Throttle control dial	●	
Automatic travel speed (low / high)	●	
4 different working modes	●	
Sliding windscreen and removable lower windscreen	●	
Openable left door window	●	
Upper and lower windshield wiper	●	
Joysticks and pedals	●	
Travel pedals and control levers	●	
Proportional controlled pedals and joysticks		0
Electric horn	●	
Interior light	●	
Cup-holder	●	
Convenient storage	●	
Convenient storage (for equipment)	●	
Heating & Cooling box	●	
Easy-cleaned floor	●	
12V power socket	●	
Computer connection port	●	
Radio / mp3 / usb / Aux	●	
Detachable Movement Levers		0

Lower Frame	Standard	Optional
Narrow Lower Chassis (NLC)		0
Track width options 700/800		0
Lubricated and sealed track components	●	
Dozer blade		0
Mooring points for shipment	●	
Safety		
ROPS (Roll Over Protective Structure)	●	
FOPS (Falling Object Protective Structure)	●	
Rear view camera	●	
Side view camera		0
Right and left rear view mirrors	●	
Working lamps	●	
LED working lamps		0
Rotating beacon		0
Swing and travel alarm		0
Emergency engine stop switch	●	
Pilot operated and automatically released swing brake	●	
Boom and arm cylinder safety valve		0
Overload warning system		0
Battery cut-off switch	●	
Handrails by the steps and on the upper frame	●	
Perforated metal non-slip plates	●	
Safety locking device	●	
Safety glass	●	
Emergency hammer	●	
Lockable fuel tank cover	●	
Upper and lower guards for windshield		0
Operator's cab ceiling guard		0
Miscellaneous		
Telematic system (HIDROMEK Smartlink)		0
GEO System		0
Fuel transfer pump with automatic stop	●	
Water sensor on fuel pre-filter	●	
Bio oil B7	●	
Alternator - Battery	●	
Battery Charge Indicator	●	
Automatic lubrication system		0
Working lamp guards		0
Hydraulic breaker return line filter		0
Double pump combination function		0
Choosing single or double acting attachment on the instrument panel		0
Choosing the control method for the optional attachment		0
Boom cylinder piping guard		0
Bucket cylinder rod guard		0
Warning horn	●	
Counterweights		0

● STANDARD 0 OPTIONAL

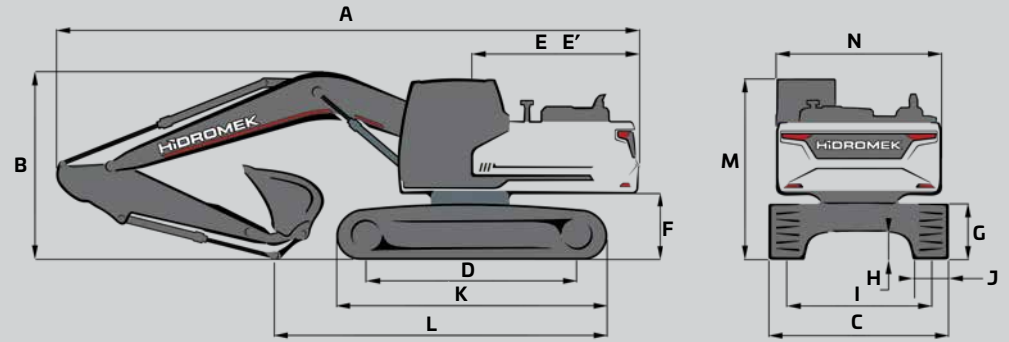
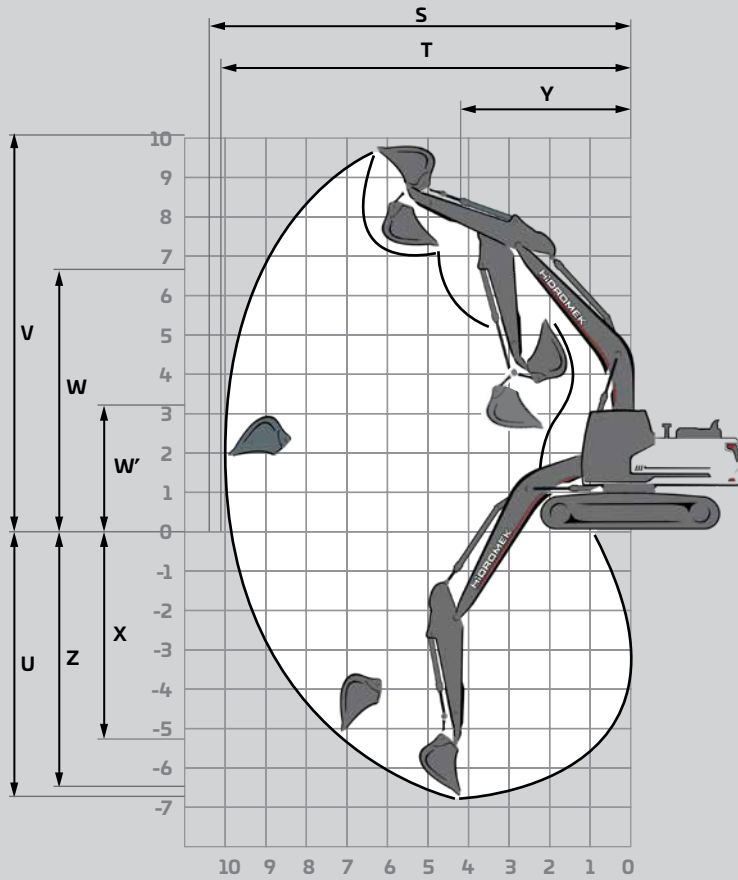

DIMENSIONS

		LC HD				NLC	
		Mono Boom				LR	Mono Boom
		6,10	6,50	6,50	6,50	10,00	6,10
BOOM (m)		6,10	6,50	6,50	6,50	10,00	6,10
ARM (m)		*2,60	2,60	3,20	4,00	6,00	2,60
GENERAL DIMENSIONS (mm)	A) Overall Length	10.920	11.410	11.380	11.400	14.930	11.020
	B) Overall height (to top of boom)	3.640	3.510	3.510	3.720	3.370	3.640
	C) Overall Width	3.300	3.300	3.300	3.300	3.500	2.990
	D) Distance between tumblers	4.240	4.240	4.240	4.240	4.240	4.240
	E) Distance from center of swing to rear end	3.585	3.585	3.585	3.585	3.660	3.540
	E') Tail swing radius	3.540	3.540	3.540	3.540	3.680	3.560
	F) Counterweight Clearance	1.250	1.250	1.250	1.250	1.250	1.250
	G) Track Height	1.090	1.090	1.090	1.090	1.090	1.090
	H) Ground Clearance	500	500	500	500	505	505
	I) Track Gauge	2.700	2.700	2.700	2.700	2.700	2.390
	J) Shoe Width	600	600	600	600	800	600
	K) Track Length	5.190	5.190	5.190	5.190	5.190	5.190
	L) Length on ground (transport)	6.670	7.140	6.200	5.550	6.790	6.670
	M) Overall height of cab	3.190	3.190	3.190	3.190	3.190	3.190
N) Overall width of upperstructure	2.990	2.990	2.990	2.990	2.990	2.990	
WORKING RANGES (mm)	S) Maximum Digging Reach	10.380	10.720	11.320	12.030	16.920	10.380
	T) Maximum Digging Reach on Ground Level	10.150	10.500	11.120	11.840	16.790	10.150
	U) Maximum Digging Depth	6.560	6.970	7.570	8.370	11.870	6.560
	V) Maximum Digging Height	10.020	10.010	10.460	10.680	15.390	10.020
	W) Maximum Dumping Height	6.870	6.950	7.330	7.580	12.490	6.870
	W') Minimum Dumping Height	3.070	3.320	2.740	1.950	3.780	3.070
	X) Maximum Vertical Digging Depth	5.050	5.000	5.900	6.520	11.260	5.050
	Y) Minimum Swing Radius	4.110	4.480	4.500	4.620	5.630	4.110
	Z) Maximum Digging Depth (2440 mm level)	6.380	6.770	7.410	8.230	11.770	6.380

* Standard

FORCES

		LC HD				NLC	
		Mono Boom				LR	Mono Boom
	BOOM (m)	6,10	6,50	6,50	6,50	10,00	6,10
	ARM (m)	*2,60	2,60	3,20	4,00	6,00	2,60
SAE	Bucket Digging Force	19400	19400	19.600	19.500	9.200	19.400
	Bucket Digging Force (Power Boost)	21.100	21.100	21.200	21.200	-	21.100
	Arm Crowd Force	19.100	19.100	16.100	13.900	7.200	19.100
	Arm Crowd Force (Power Boost)	20.800	20.800	17.500	15.100	-	20.800
ISO	Bucket Digging Force	23.300	22.900	22.900	22.900	10.400	22.900
	Bucket Digging Force (Power Boost)	25.300	24.800	24.800	24.800	-	24.800
	Arm Crowd Force	20.400	20.200	16.900	14.500	7.300	20.200
	Arm Crowd Force (Power Boost)	22.100	22.000	18.400	15.700	-	22.000

A- Material density less than 2.000 kg/m³
 B- Material density less than 1.800 kg/m³
 C- Material density less than 1.500 kg/m³
 D- Material density less than 1.200 kg/m³

STANDARD BUCKET



	Width	1.750 mm
	Capacity (SAE)	*2,2 m ³
	Weight	1,950 kg
	Number of Teeth	5
ARM	2,20 m	A
	*2,60 m	B
	3,20 m	C
	4,00 m	D

* Standard

OPTIONAL BUCKET SELECTION SCHEME

General Purpose Bucket



Heavy Duty Type Bucket



1.650 mm	1.800 mm	2.000 mm	1.150 mm	1.265 mm	1.400 mm	1.525 mm	1.650 mm	1.930 mm
1,80 m ³	2,0 m ³	2,20 m ³	1,20 m ³	1,40 m ³	1,60 m ³	1,80 m ³	2,0 m ³	2,4 m ³
1.750 kg	1.880 kg	2.000 kg	1.420 kg	1.500 kg	1.630 kg	1.700 kg	1.850kg	2.140 kg
5	5	6	4	4	5	5	5	6
A	A	A	A	A	A	A	A	B
A	A	B	A	A	A	A	A	C
A	B	C	A	A	A	A	B	D
C	C	D	A	A	B	C	C	-

HEAVY DUTY

QUICK COUPLER



ROCK TYPE BUCKET



RIPPER



CLEANING BUCKET



ATTACHMENTS

LIFTING CAPACITY (kg)													HMK390 LC HD		
	Boom: 6,1 m		Arm: 2,6 m		Without bucket		STD, 600 mm Crawler		CW: 6500 kg				📏 : Front	📏 : Side	
A, m	1,5		3,0		4,5		6,0		7,5		9,0		Maximum Reach		
B, m	📏	📏	📏	📏	📏	📏	📏	📏	📏	📏	📏	📏	📏	📏	R, m
7,5							*9650	*9650					*9400	*9400	6,67
6,0							*10000	*10000	*9400	7950			*9000	7650	7,66
4,5					*14000	*14000	*11100	10950	*9700	7750			*9000	6650	8,26
3,0					*17050	15650	*12450	10350	*10300	7500			*9350	6150	8,56
1,5					*18850	14750	*13550	9850	*10850	7250			*9550	6000	8,58
0 (Ground)					*19000	14450	*14000	9550	*11000	7050			*9750	6150	8,33
-1,5			*20100	*20100	*17900	14500	*13550	9500	*10450	7050			*9850	6750	7,78
-3,0			*20200	*20200	*15600	14750	*11850	9650					*9750	8150	6,85
-4,5					*11000	*11000							*8800	*8800	5,36

LIFTING CAPACITY (kg)													HMK390 LC HD		
	Boom: 6,5 m		Arm: 2,6 m		Without bucket		STD, 600 mm Crawler		CW: 6500 kg				📏 : Front	📏 : Side	
A, m	1,5		3,0		4,5		6,0		7,5		9,0		Maximum Reach		
B, m	📏	📏	📏	📏	📏	📏	📏	📏	📏	📏	📏	📏	📏	📏	R, m
7,5													*8850	8550	7,20
6,0							*9550	*9550	*8750	7900			*8650	6900	8,13
4,5					*14050	*14050	*10800	10750	*9250	7650			*8650	6050	8,70
3,0							*12200	10100	*9950	7350			*8750	5600	8,98
1,5							*13300	9600	*10550	7050			8800	5450	9,00
0 (Ground)					*18550	14100	*13700	9300	*10800	6900			*9050	5600	8,76
-1,5					*17550	14150	*13400	9250	*10500	6850			*9200	6100	8,24
-3,0			*19800	*19800	*15600	14400	*12100	9400					*9200	7200	7,37
-4,5			*15000	*15000	*12050	*12050	*8700	*8700					*8650	*8650	6,01

LIFTING CAPACITY (kg)													HMK390 LC HD		
	Boom: 6,5 m		Arm: 3,2 m		Without bucket		STD, 600 mm Crawler		CW: 6500 kg				📏 : Front	📏 : Side	
A, m	1,5		3,0		4,5		6,0		7,5		9,0		Maximum Reach		
B, m	📏	📏	📏	📏	📏	📏	📏	📏	📏	📏	📏	📏	📏	📏	R, m
9,0													*6000	*6000	6,59
7,5									*7950	*7950			*5450	*5450	7,89
6,0									*8050	8050			*5250	*5250	8,74
4,5					*12650	*12650	*10000	*10000	*8650	7750	*8000	5750	*5300	*5300	9,27
3,0					*15900	15600	*11550	10250	*9450	7400	*8300	5600	*5450	5100	9,54
1,5					*18100	14550	*12850	9700	*10200	7100	*8650	5450	*5800	4950	9,55
0 (Ground)					*18700	14100	*13550	9300	*10650	6850	8650	5350	*6450	5050	9,33
-1,5			*15600	*15600	*18150	14050	*13550	9200	*10600	6750			*7500	5450	8,84
-3,0	*18350	*18350	*22550	*22550	*16650	14200	*12650	9250	*9750	6800			*8700	6250	8,04
-4,5			*18150	*18150	*13800	*13800	*10450	9500					*8550	8050	6,82

LIFTING CAPACITY (kg)												HMK 390 NLC			
	Boom: 6,1 m		Arm: 2,6 m		Without bucket		STD, 600 mm Crawler		CW: 7500 kg				📍 : Front	📍 : Side	
A, m	1,5		3,0		4,5		6,0		7,5		9,0		Maximum Reach		
B, m	📍	📍	📍	📍	📍	📍	📍	📍	📍	📍	📍	📍	📍	📍	A, m
7,5							*9700	*9700					*9450	9000	6,67
6,0							*10050	10050	*9400	7350			*9050	7100	7,66
4,5					*14050	*14050	*11150	10100	*9750	7200			*9050	6150	8,26
3,0					*17100	14150	*12500	9500	*10350	6950			*9400	5700	8,56
1,5					*18950	13350	*13600	9050	*10900	6700			9600	5550	8,58
0 (Ground)					*19050	13050	*14050	8750	*11050	6500			9750	5700	8,33
-1,5			*20150	*20150	*18000	13100	*13600	8700	*10500	6500			*9900	6250	7,78
-3,0			*20300	*20300	*15700	13300	*11900	8850					*9800	7500	6,85
-4,5					*11050	*11050							*8850	*8850	5,36

LIFTING CAPACITY (kg)												HMK 390 LC LR			
	Boom: 10,0 m		Arm: 6,0 m		Without bucket		STD, 800 mm Crawler		CW: 8500 kg				📍 : Front	📍 : Side	
A, m	3,0		6,0		9,0		12,0		15,0		18,0		Maximum Reach		
B, m	📍	📍	📍	📍	📍	📍	📍	📍	📍	📍	📍	📍	📍	📍	A, m
12,0													*2350	*2350	11,79
9,0							*4100	*4100					*2200	*2200	13,78
6,0					*5400	*5400	*4350	4150					*2200	*2200	14,92
3,0			*10000	*10000	*6300	5800	*4750	3750	*3650	2500			*2350	*2350	15,39
0 (Ground)			*7150	7150	*7000	5050	*5050	3350	*3750	2350			*2650	*2300	15,27
-3,0	*4050	*4050	*8300	8200	*7100	4700	*5100	3150					*3250	2400	14,52
-6,0	*6700	*6700	*9350	8450	*6400	4700	*4500	3200					*3850	2900	13,06
-9,0			*6450	*6450	*4500	*4500							*3400	*3400	10,57

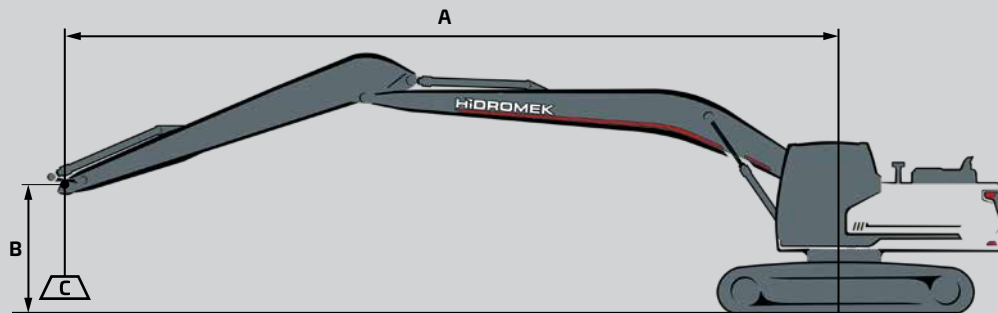
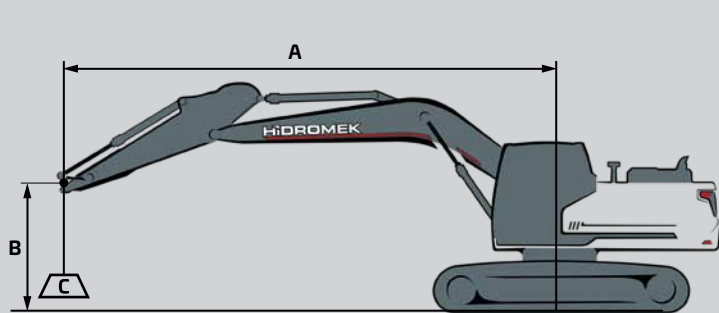

- A Load Radius
- B Load Point Height
- C Lifting Capacity

1. The above loads are in compliance with SAE J1097 and ISO 10567 Hydraulic Excavator Lifting Capacity Standards
2. The load point is the center-line of the bucket pivot mounting pin on the arm
3. Lifting capacity cannot exceed 75% of tipping capacity or 87% of hydraulic capacity.
4. (*) indicates load limited by hydraulic capacity.

HİDROMEK®

HEAD OFFICE

Address : Ahi Evran OSB Mahallesi,
Osmanlı Caddesi, No:1, 06935
Sincan-ANKARA/TÜRKİYE

Phone : +90 312 267 12 60

Fax : +90 312 267 12 39

E-mail: export@hidromek.com.tr

AFTER SALES SERVICE

Address : İstanbul Yolu 17. Km,
Şehit Osman Avcı Mahallesi,
No: 479, Etimesgut-ANKARA/TÜRKİYE

Phone : +90 312 280 87 40

Fax : +90 312 280 87 48

HİDROMEK® WEST

HIDROMEK MAQUINARIA DE CONSTRUCCION ESPAÑA S.L.

Address : Avenida Del Progres 7 08840 –
Viladecans Barcelona/ SPAIN

Phone : +34 93 638 84 65

E-mail : info@hidromek.es

HİDROMEK® JAPAN

Address : 5-10, Hashimoto 6-chome,
Midori-Ku, Sagamihara,
Kanagawa, 252-0143 JAPAN

Phone : +81 42 703 0261

Fax : +81 42 703 0262

E-mail : Kiyoko.Shinoda@hidromek.com

HİDROMEK® RUS

Address : 72, Zhivopisnaya str, Building A,
village Oktyabrskiy,
Krasnodar, 350032, RUSSIA

Phone : +7 861 290 3007

E-mail : hidromekrus@hidromek.ru

HİDROMEK® HCE

HİDROMEK Construction Equipment (Thailand) Ltd.

Address : Amata City Chonburi Industrial Estate Phase 7,
No. 700/669 Moo 1, T.Phanthong,
A.Phanthong, Chonburi 20160, TAYLAND

Phone : +66 38 447 349

Fax : +66 38 447 355

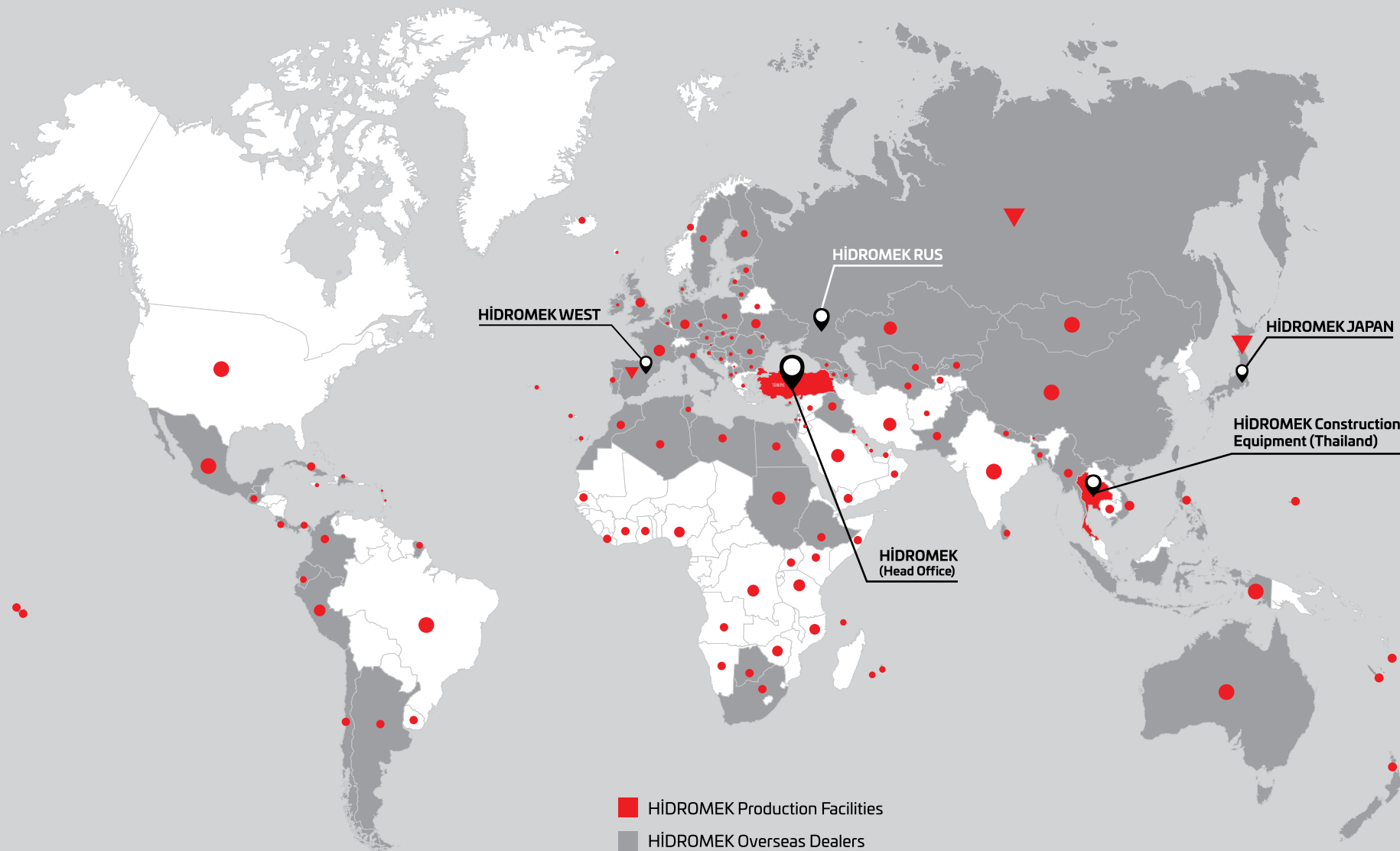

HÍDROMEK WEST

HÍDROMEK RUS

HÍDROMEK JAPAN

HÍDROMEK Construction Equipment (Thailand)

HÍDROMEK (Head Office)

- HÍDROMEK Production Facilities
- HÍDROMEK Overseas Dealers
- ▼ HÍDROMEK Overseas Sales and Aftersales Services Points
- Countries HÍDROMEK Machines Running

HIDROMEK®

Together Stronger

www.hidromek.com

[f hidromek.tr](https://www.facebook.com/hidromek.tr) [X Hidromek](https://x.com/Hidromek) [ig hidromekofficial](https://www.instagram.com/hidromekofficial) [yt HidromekTv](https://www.youtube.com/HidromekTv) [in company/hidromek](https://www.linkedin.com/company/hidromek)

